

INSTALLATION INSTRUCTIONS

CRL FIRE ESCAPE SECURITY SCREEN

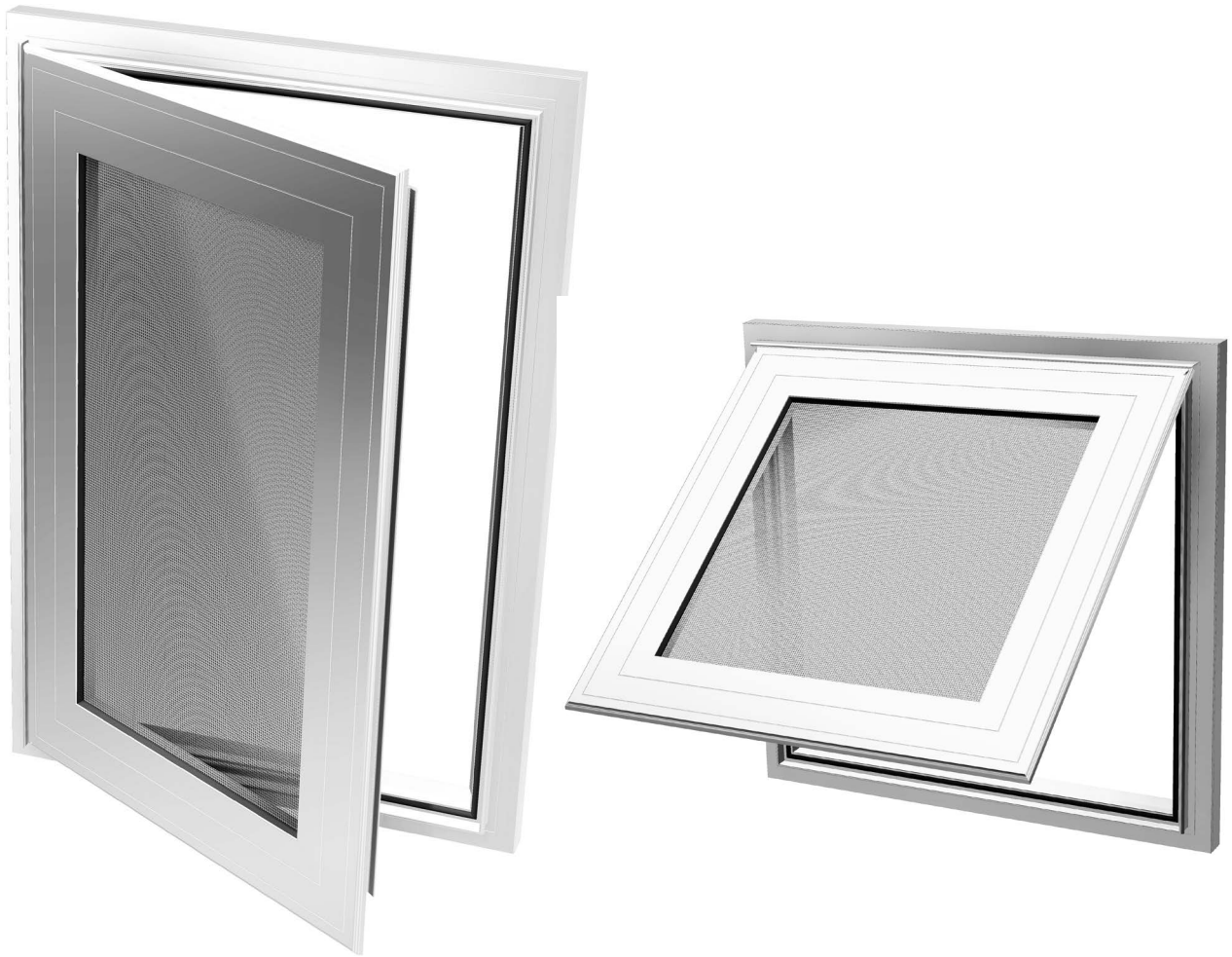

Phone: (800) 421-6144 • Fax: (866) 921-0531
crlaurence.com • usalum.com • crl-arch.com

MODEL IDENTIFICATION

All CRL Fire Escape Security Screens are fabricated specifically for each order and shipped fully assembled. The frame is installed over an existing exterior window.

NOTE: The Installer is responsible for verifying that the existing window be operable and egress code compliant prior to installing the CRL Security Screen System.

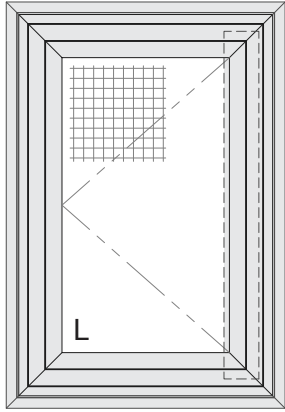

Left Hand

GWEH_
Fire Escape Side Hung Window

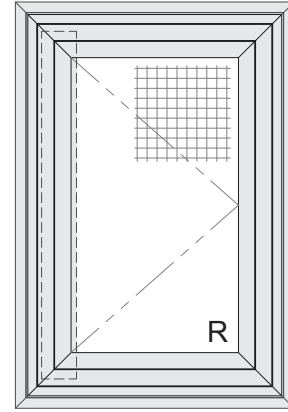

Right Hand

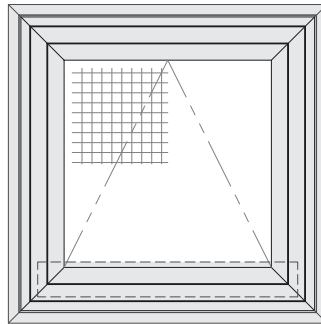

GWEHT_
Fire Escape Top Hung Window

RECOMMENDED FASTENERS

T20 Bronze Star Exterior Coated Screws are recommended for all CRL Security Screen installations.

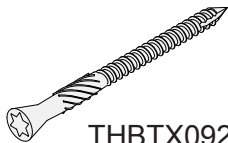

THBTX0920

#9 x 2" (51 mm) T20 Bronze Star Trim Head Star Drive Screws

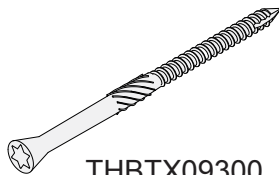

THBTX09300

#9 x 3" (76 mm) T20 Bronze Star Trim Head Star Drive Screws

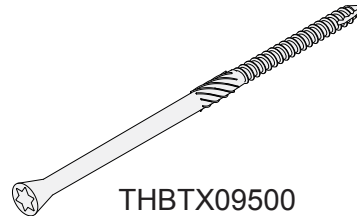

THBTX09500

#9 x 5" (127 mm) T20 Bronze Star Trim Head Star Drive Screws

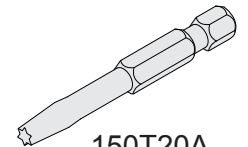

150T20A

1/4" Hex T20 Torx® Insert Bit - 2" Long

IMPORTANT: READ THIS MANUAL THOROUGHLY BEFORE BEGINNING INSTALLATION.

ORDER OF ASSEMBLY AND INSTALLATION

Model Identification	2
Recommended Fasteners	2
Installation	3 - 4

NOTE: Model GWEH_ CRL Fire Escape Security Screen for Side Hung Window installation shown in this manual.

INSTALLATION

- ① Center frame with screen over opening. Square and plumb.

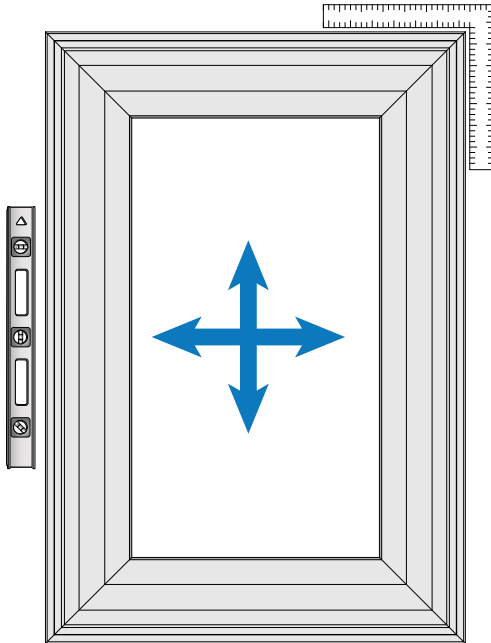

- ② Drill pilot holes and insert screws at top and bottom corners. NOTE: Space screws 3" (76 mm) from corners.

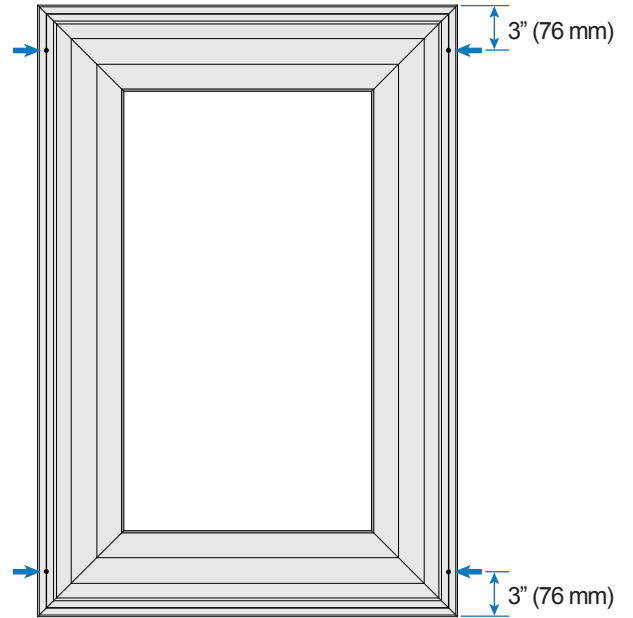

- ③ Drill pilot hole and insert screw to secure frame.

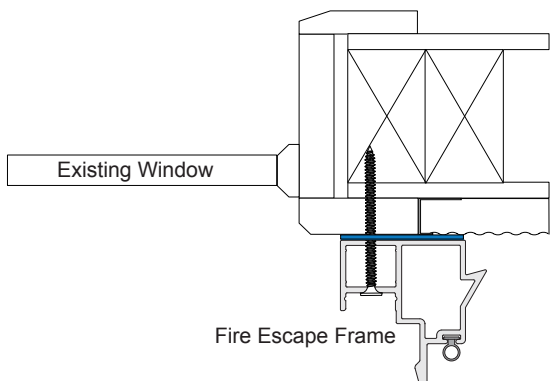
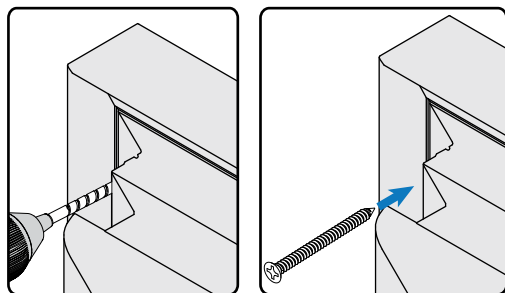

- ④ Check security screen operation.

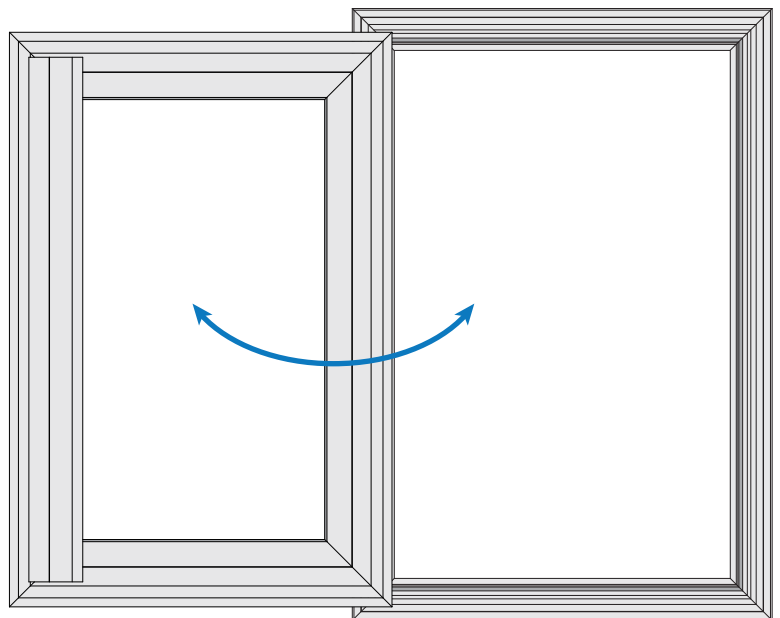

INSTALLATION (CONTINUED)

- ⑤ Space remaining screws 10" to 12" (254 to 305 mm) apart and 3" (76 mm) from corners.

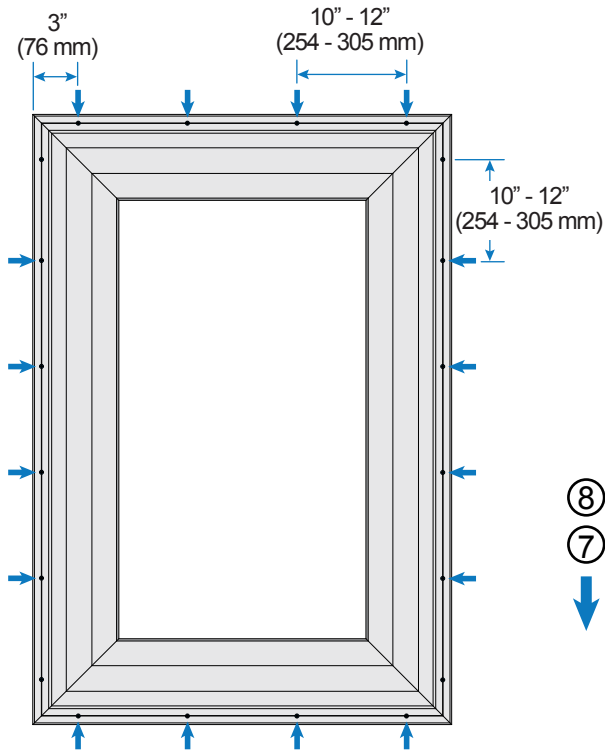

- ⑥ Tap Bottom Face Cap with rubber mallet and wood block to install. Begin at one side and work to the other.

- ⑦ Repeat to install Side Face Caps.

- ⑧ Finish with Top Face Cap.

